

A kinetic study of the electrochemical oxidation of maleic acid on boron doped diamond

ELSA WEISS¹, KARINE GROENEN-SERRANO^{1,*}, ANDRÉ SAVALL¹ and CHRISTOS COMNINELLIS²

¹Laboratoire de Génie Chimique UMR 5503, Université Paul Sabatier, 31062, Toulouse Cedex 9, France

²Institut du Génie Chimique, Ecole Polytechnique Fédérale, 1015, Lausanne, Switzerland

(*author for correspondence, fax: +33-0-5-61-55-61-39, e-mail: serrano@chimie.ups-tlse.fr)

Received 14 February 2006; accepted in revised form 3 April 2006

Key words: electrooxidation, boron doped diamond, wastewaters, maleic acid, oxalic acid, formic acid

Abstract

Maleic acid (MA) is one of the main intermediates formed during mineralization, by electrooxidation, of aromatic compounds contained in aqueous wastes. This work investigates oxidation of maleic acid with or without the presence of oxalic acid (OA) and formic acid (FA) in aqueous solution by using boron-doped diamond (BDD) electrodes. OA and FA are the main products formed in MA electrooxidation. Voltammetric studies conducted with a BDD electrode of small surface (0.196 cm²) show that MA oxidation takes place at a potential very close to that of the discharge of water. But, under potentiostatic conditions and at concentrations higher than 0.001 M, adsorption of MA blocks its own oxidation. Oxalic and formic acids are oxidized before the discharge of water. Again, the presence of maleic acid blocks the oxidation of formic and oxalic acids. Galvanostatic electrolyses of aqueous solutions of MA, OA, FA and mixtures of these acids were conducted on a BDD electrode. Electrolyses were controlled by measurements of Total Organic Carbon, Chemical Oxygen Demand and by Liquid Chromatography. Results showed that MA was totally mineralized; FA and OA were very low concentration intermediaries. Electrolyses of solutions containing MA, initially in the presence of OA or FA, showed that the OA was oxidized at the same rate as the MA, whereas the FA oxidation began only when the MA had completely disappeared. These results suggest that OA oxidizes by a mass transport limited process coupled with a direct electron transfer with the anode. Under galvanostatic conditions, maleic acid and formic acid are probably oxidized via OH[•] radicals generated by water discharge.

1. Introduction

Many wastewaters produced in industrial processes contain organic contaminants. The best established and relatively cheap method of decreasing the chemical oxygen demand (COD) of wastewaters is based on biological treatment. But, unfortunately, certain substances responsible for COD are not easily biodegradable. In particular, toxic substances can inactivate the microorganisms and slow down biological processes. Other methods for COD removal are thus required in the presence of refractory and/or toxic compounds.

Among physicochemical methods, electrochemistry can achieve direct degradation of organics into carbon dioxide and water. The electrochemical oxidation of organics to CO₂ occurs at a significant rate in the potential region of oxygen evolution. It is commonly assumed that electrogenerated hydroxyl radicals, the most powerful oxidants in water [1, 2] are active in the degradation of organic molecules. Hydroxyl radicals are

produced in the anodic reaction directly from water according to Equation (1):



A wide variety of electrode materials have been suggested to destroy organics in aqueous effluents. The general mechanism of electrochemical incineration is as follows:

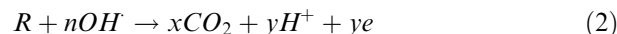

For practical application, the choice of the anodic material having the required catalytic properties is decisive. The electrochemical activity and the service life of the electrode constitute the main criteria. Graphite, tin dioxide [3, 4] or lead dioxide [5], and also the recently developed synthetic boron-doped diamond electrode [2, 6–8] have been used. Lead dioxide electrodes are commercially available [9]. This material is efficient in generating hydroxyl radicals for the complete

mineralization of organic substances [5, 10]. Among new materials, boron doped diamond (BDD) has interesting electrochemical properties: its electrochemical window is about 3 V for a 1 mol L⁻¹ sulphuric acid solution and its chemical resistance in acid and caustic media is very high [6].

The model compound most frequently studied on BDD anodes is phenol; its electrochemical oxidation tends to form water and carbon dioxide at the final stage. Maleic acid (HOOC-CH=CH-COOH) is one of the main intermediates obtained after opening of the aromatic ring. Oxalic (HOOC-COOH) and formic (HCOOH) acids appear in the final steps of the oxidation process. The electrochemical behaviour of MA in oxidation is of great interest because this molecule is the hinge between cyclic and linear structures. Knowing that OA and FA can be intermediates in MA degradation, it is important to know the behaviour of these acids and of their mixtures in solutions containing MA. So we have investigated oxidation of MA alone and then considered the case of solutions containing different combinations of these acids.

2. Experimental

2.1. Electrochemical measurements

Electrochemical measurements were carried out in a conventional three-electrode cell (50 cm³) using a computer controlled Autolab potentiostat model 30. Boron doped diamond was used as working electrode (0.196 cm²) and Pt as counter electrode. A mercurous sulfate electrode (Hg/Hg₂SO₄, SO₄²⁻; 0.650 V vs SHE) was used as reference electrode (MSE).

At first, the BDD electrode was treated by scanning ten times (from -1.4 to 2.1 V vs MSE, at 50 mV s⁻¹) into a molar sulphuric acid solution. Immediately after this pre-treatment, the BDD electrode was rinsed with distilled water, plunged into a 1 M perchloric acid solution and then subjected to a potential scan from the rest potential to 2.1 V, and then between 2.1 and -1.4 V vs MSE. In the presence of carboxylic acids, voltammetric curves were recorded from open circuit potential (around 0.03 V) to 2.1 V in oxidation and back to -1.4 V in reduction. The limiting potential of 2.1 V vs MSE in oxidation was chosen to avoid oxygen evolution during curve plotting.

2.2. Electrolysis and electrode material

Electrolyses were performed in a one-compartment electrolytic flow cell under galvanostatic conditions (Figure 1). The volume of solution for each operation was 0.5 L. Diamond was used as anode and zirconium as cathode. All electrodes were disks (diameter 90 mm) with a geometric area of 50 cm² each. The inter-electrode gap was 10 mm. The electrolyte was stored in a 0.5 L thermoregulated glass reservoir (1) and

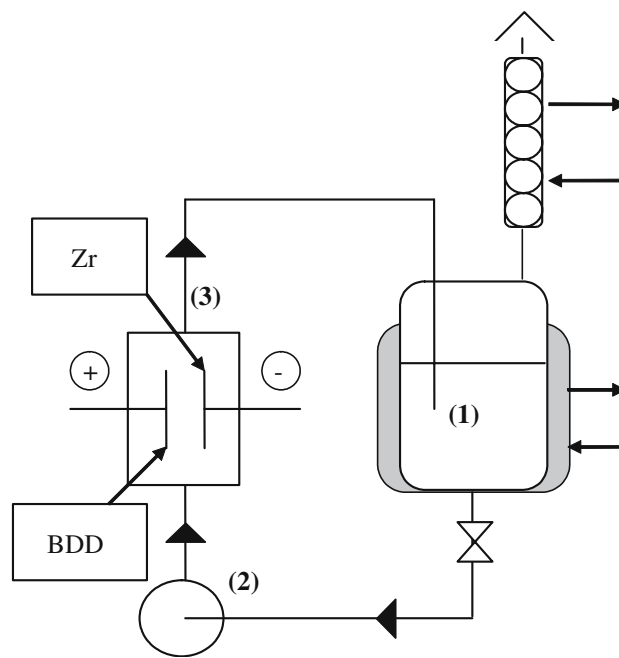

Fig. 1. Discontinuous process with a single compartment electrochemical reactor, (1) 0.5 L tank; (2) centrifugal pump; and (3) electrochemical cell.

circulated through the electrolytic cell using a centrifugal pump (2). The flow rate in the electrochemical cell was 200 L h⁻¹. The current density value used was 40 mA cm⁻². The electrolyte was a 1 M HClO₄ solution. Maleic acid was supplied by Aldrich (99% purity). Formic acid (Normapur, 99% purity) and oxalic acid (pure) were supplied by Prolabo.

Boron-doped diamond films were synthesized by the hot filament chemical vapor deposition technique (HF CVD) on conducting p-Si substrate (0.1 Ωcm, Siltronix). The filament temperature ranged from 2440 to 2560 °C and the substrate one was kept at 830 °C. The reactive gas used was methane in an excess of dihydrogen (1% CH₄ in H₂). The doping gas was trimethylboron with a concentration of 3 ppm. The gas mixture was supplied to the reaction chamber, providing a 0.24 μm h⁻¹ growth rate for the diamond layer. The diamond films were about 1 μm thick. This HF CVD process produces columnar, randomly textured, polycrystalline films [11].

2.3. Analytical procedures

The Chemical Oxygen Demand was determined by photometry using COD test tubes and the photometer was a Dr Lange Lasa 50 system. The Total Organic Carbon analysis was carried out with a Shimadzu TOC-VSCN total organic carbon analyzer. Concentrations of MA and of its products like OA and FA were quantified by liquid chromatography (HP series 1100). The column used was Supelcogel C-610H; the mobile phase was a 0.018 M phosphoric acid solution and detection was made at 210 nm.

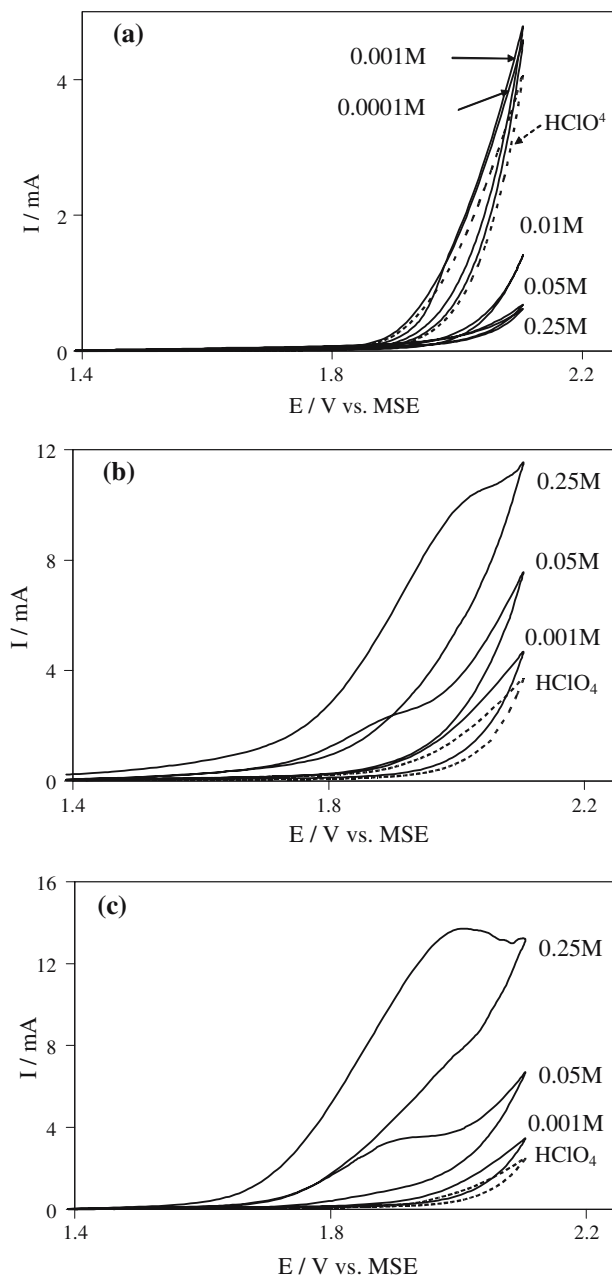

Fig. 2. Cyclic voltammograms: (a) maleic acid; (b) oxalic acid; and (c) formic acid at different concentrations in 1 M perchloric acid. Working electrode: BDD (0.196 cm²), Counter Electrode: Pt, Reference electrode: MSE. Scan rate: 50 mV s⁻¹.

3. Results and discussion

3.1. Voltammetric study

3.1.1. Study of each acid

Cyclic voltammograms of solutions containing various concentrations of MA (from 0.0001 to 0.25 M), OA and FA (from 0.001 to 0.25 M) in 1 M aqueous perchloric acid are shown in Figure 2.

Figure 2(a) shows that for maleic acid the voltammograms corresponding to the lowest concentrations (0.0001 and 0.001 M) present a specific oxidation current. This oxidation signal is very close to the oxygen

evolution region (2.0–2.1 V vs MSE). In agreement with Cañizares et al. [8]. This fact suggests that within this concentration range MA is oxidized by direct electron transfer. For MA concentrations above 0.01 M, the voltammograms are entirely situated below the residual current. As the initial pre-treatment of the electrode was carried out before each curve was recorded, it seems clear that the inhibition of the interface results from MA adsorption. Adsorption of MA was previously observed on Pt [12]. Above 0.05 M, the surface is probably totally saturated because the curves no longer vary. Figure 2(b) presents cyclic voltammograms for oxalic acid at concentrations between 0.001 M and 0.25 M. The increase in OA concentration (≥ 0.05 M) leads to the appearance of an oxidation wave before the discharge of water. So this oxidation does not imply transfer of an oxygen atom: it is a phenomenon of direct electron transfer to the BDD:

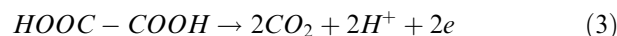

This reaction is mass-transfer limited because the ratio of the currents on the pseudo-plateaus, at a potential of 2 V vs MSE, is comparable to the ratio of the two highest concentrations (cf. 0.05 and 0.25 M solutions). In the case of formic acid (Figure 2(c)) the oxidation wave occurs once again before the discharge of water. As in the case of oxalic acid, the currents measured on pseudo-plateaus (2 V vs MSE) are proportional to the concentration. It is obvious that the direct oxidation of FA (Eq. 4) is mass-transfer limited.

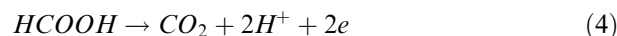

In summary, under potentiostatic conditions, the oxidation of MA is inhibited by its adsorption onto the BDD electrode while the oxidation of OA and FA corresponds to a direct electron-transfer mechanism at a potential below that for water discharge.

3.1.2. Study of solutions containing MA + OA, MA + FA and MA + OA + FA

Cyclic voltammograms for solutions of 1 M perchloric acid containing MA + OA or MA + FA or MA + OA + FA, each acid at a concentration of 0.05 M, are presented in Figure 3. Voltammograms obtained with solutions containing two or three carboxylic acids are presented simultaneously with the one obtained for only one carboxylic acid. In the 3 cases of Figure 3, the presence of maleic acid causes a very strong decrease in the current on the pseudo-plateaus for oxidation of OA or FA. Voltammograms obtained in the presence of MA and FA (or MA and OA) show, before the discharge of water, a shoulder much lower in height than the one observed in the case of OA or FA alone. So the presence of maleic acid at a concentration of 0.05 M inhibits the oxidation of OA and FA. It is likely that MA adsorption prevents direct electron transfer between these acids and the electrode. In the potentiostatic mode, it is necessary to set a higher potential to initiate this oxidation.

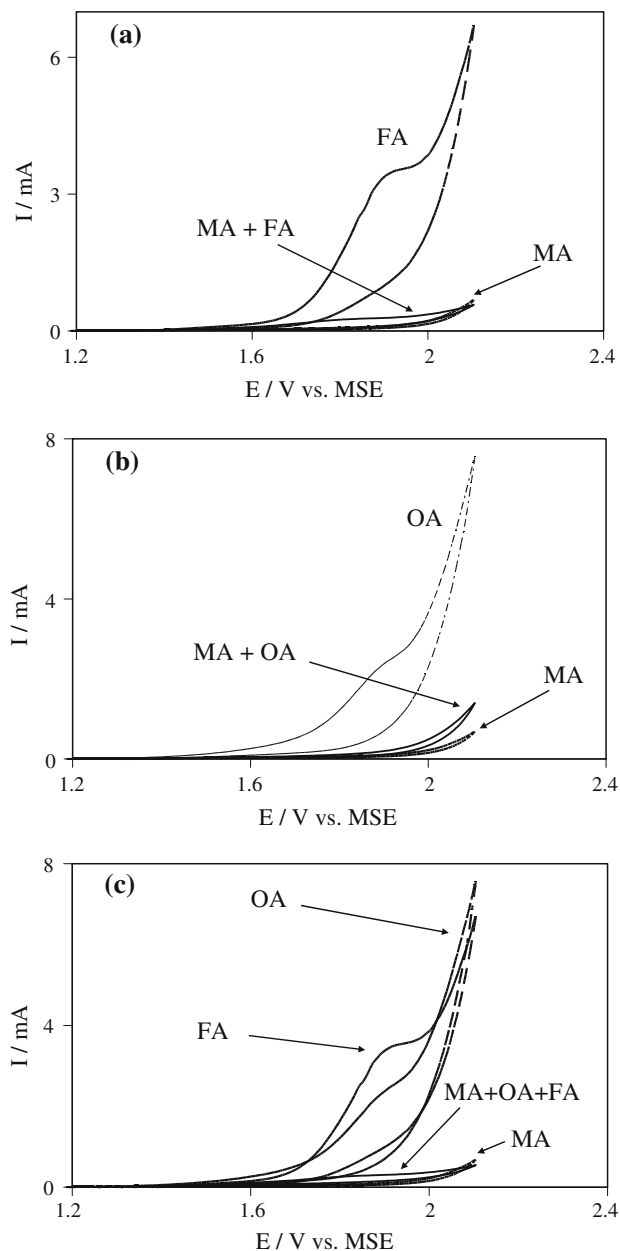

Fig. 3. Cyclic voltammograms: (a) maleic and formic acids; (b): maleic and oxalic acids; (c): maleic, oxalic and formic acids in 1 M perchloric acid. All concentrations of carboxylic acids are 0.05 M. Working electrode: BDD (0.196 cm²), Counter Electrode: Pt, Reference electrode: MSE. Scan rate: 50 mV s⁻¹.

3.2. Galvanostatic electrolyses

From the concept of limiting current density, two electrolysis regimes can be defined: one is controlled by diffusion and the other by charge transfer. The limiting current depends on C the concentration of the reactant in solution, z the number of electrons exchanged and the hydrodynamic conditions expressed in terms of the mass-transfer coefficient k_d . The mean value of k_d was determined using the ferri/ferro system in the experimental cell, under the same hydrodynamic conditions ($k_d = 2 \times 10^{-5}$ m s⁻¹ for a flow rate of

200 L h⁻¹). The initial limiting current density was calculated from: $i_{lim}^0 = zFk_d C^0$. At any later time, its value could be determined from the COD (mol of O₂ L⁻¹): $i_{lim} = 4Fk_d [COD]$ [13]. The critical charge defines the point of transition from charge-transfer limitation to mass-transfer limitation. Its theoretical value for a 0.09 M solution of MA is 24 Ah L⁻¹.

3.2.1. Maleic acid

Maleic acid at a concentration of 0.09 M in 1 M perchloric acid was oxidized under a constant current density of 40 mA cm⁻². So at this concentration, the initial limiting current density calculated from the COD was 220 mA cm⁻². Figure 4 shows COD and TOC variations during the electrolysis of the 0.09 M maleic acid solution. MA can be almost entirely mineralized using a BDD anode. TOC removal reached nearly 93% for a charge of 27 Ah L⁻¹. These two curves present a change in slope around 4 Ah L⁻¹. HPLC analyses of samples of solution taken during electrolysis showed not only MA depletion, but also formation of small amounts of OA and FA (Figure 5). In the same manner, the curve of maleic acid concentration (Figure 5) presents a change in slope around 4 Ah L⁻¹. At the very beginning of the reaction (charge < 2 Ah L⁻¹) the decrease in maleic acid concentration resulted almost exclusively from its complete degradation into CO₂ and H₂O. In fact the decrease in MA concentration ($\Delta C = 0.026$ M) was only very moderately compensated by the production of oxalic and formic acids, with more FA produced than OA. The formic acid concentration reached a maximum just as the quantity of maleic acid was approaching zero. The OA concentration reached a plateau from 15 Ah L⁻¹ up to 32 Ah L⁻¹, and beyond this value the concentration started to decrease (not shown in Figure 5). The variation of slope in the concentration graph for MA oxidation could be due to the supporting electrolyte; work is in progress to verify this point. A closer study of the intermediaries produced during maleic acid oxidation would also help in explaining this behaviour.

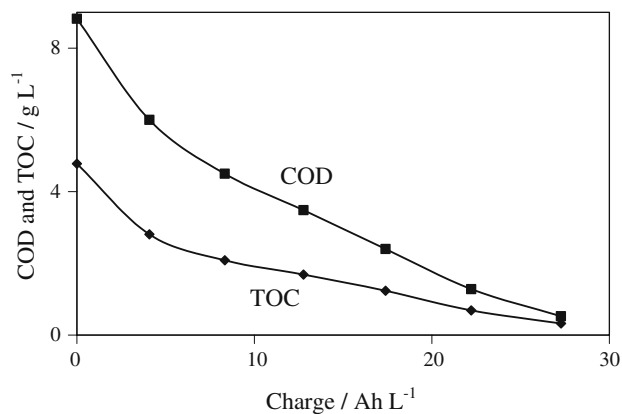

Fig. 4. TOC and COD variations during galvanostatic electrolysis of 0.5 L of 0.09 M maleic acid in 1 M perchloric acid; $I = 2$ A (40 mA cm⁻²).

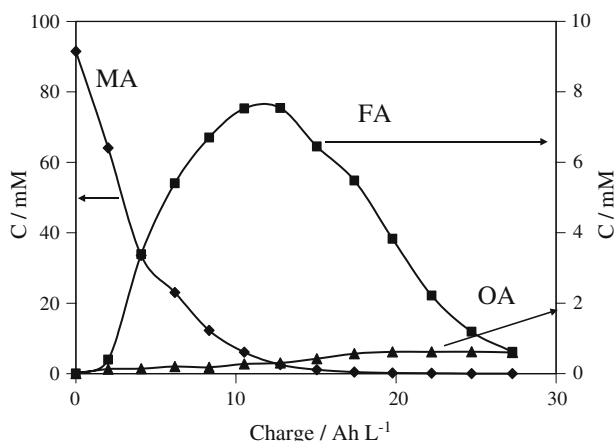

Fig. 5. Concentration variation during electrolysis of 0.5 L of 0.09 M maleic acid solution in 1 M perchloric acid; $I = 2 \text{ A}$ (40 mA cm^{-2}).

Figure 6 shows a comparison of the experimentally measured COT and the COT calculated from the concentrations of the three acids determined by HPLC. The differences suggest that other products could appear during the degradation of the MA: however OA and FA seem to be the main intermediaries in terms of carbon.

3.2.2. Maleic acid and formic acid solutions

Figure 7 shows the follow-up of the electrolysis of a solution containing initially MA and FA, both at initial concentration of 0.05 M. At the beginning of the electrolysis, MA was rapidly oxidized while FA was slowly oxidized. The rate of FA oxidation increased as the concentration of MA decreased and this oxidation rate passed through a maximum as the concentration of MA reached 0.001 M at around 10 Ah L^{-1} . The decline in MA concentration did not show two different slopes as in the previous experiment. There are two reasons for this. In the earlier experiment (Figures 4 and 5), the MA concentration was approximately twice as high. Also the environment of the electrode is different as the two acids are present from the beginning in equal concentrations. For a charge of 7 Ah L^{-1} , the MA concentration decreased by as much as 87% while the FA decreased only by 20%. The FA concentration results from a

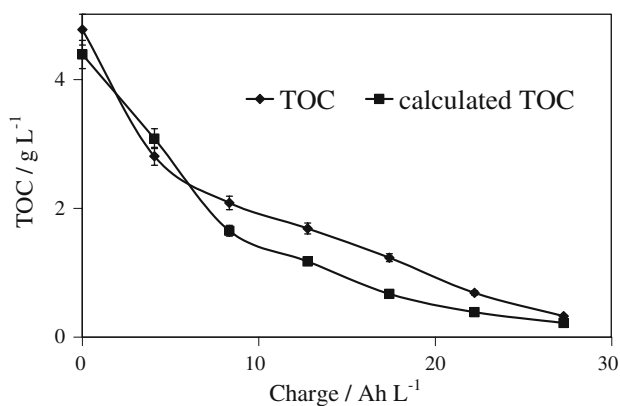

Fig. 6. Comparison between experimental TOC and calculated TOC from HPLC analysis during electrolysis of 0.5 L of 0.09 M maleic acid solution in 1 M perchloric acid; $I = 2 \text{ A}$ (40 mA cm^{-2}).

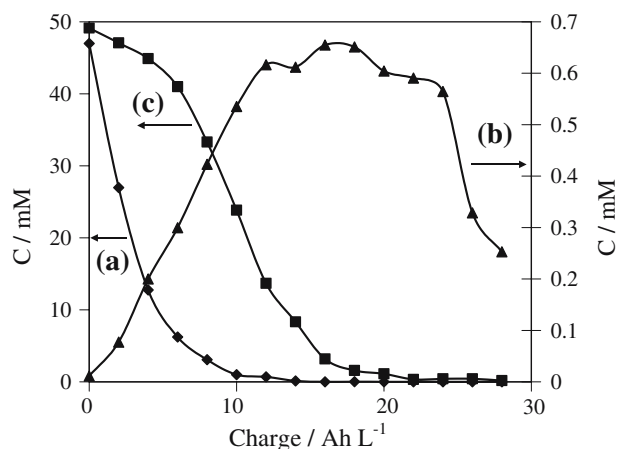

Fig. 7. Concentration variation during electrolysis of a solution (0.5 L) containing maleic acid (0.05 M) and formic acid (0.05 M) in 1 M perchloric acid. $I = 2 \text{ A}$ (40 mA cm^{-2}). (a) maleic acid; (b) oxalic acid; (c) formic acid.

balance between its consumption by oxidation and its production by MA oxidation. Now the amount of FA obtained during the electrolysis of MA was fairly small (Figure 5) and this contribution cannot explain the low rate of FA concentration decline compared with that of MA.

Kinetic data concerning reactions of the hydroxyl radical in aqueous solutions could give a suitable explanation: the rate constant for the reaction between hydroxyl radicals and FA is $1.3 \times 10^8 \text{ L mol}^{-1} \text{ s}^{-1}$ [14] while the rate constant is $6.0 \times 10^9 \text{ L mol}^{-1} \text{ s}^{-1}$ for MA [15]. These values are in good agreement with the hypothesis that oxidation is performed by hydroxyl radicals and would explain why MA disappears before FA.

3.2.3. Maleic acid and oxalic acid solutions

Figure 8 presents the variations in concentration of OA and MA for a solution electrolysed under a constant anodic current density of 40 mA cm^{-2} . The concentration variation of OA is very similar to that of MA: the

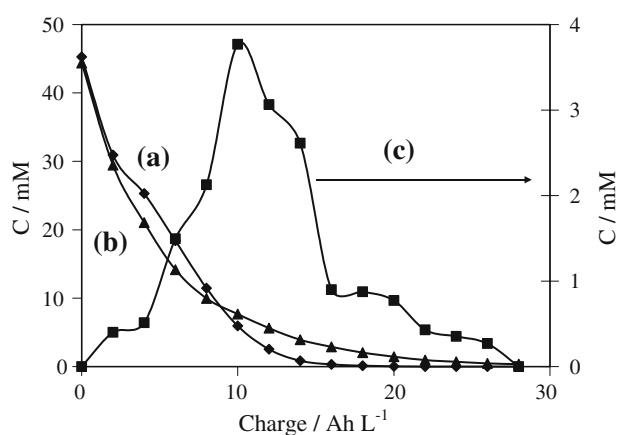

Fig. 8. Concentration variation during electrolysis of a solution (0.5 L) containing maleic acid (0.05 M) and oxalic acid (0.05 M) in 1 M perchloric acid. $I = 2 \text{ A}$ (40 mA cm^{-2}). (a) maleic acid; (b) oxalic acid; (c) formic acid.

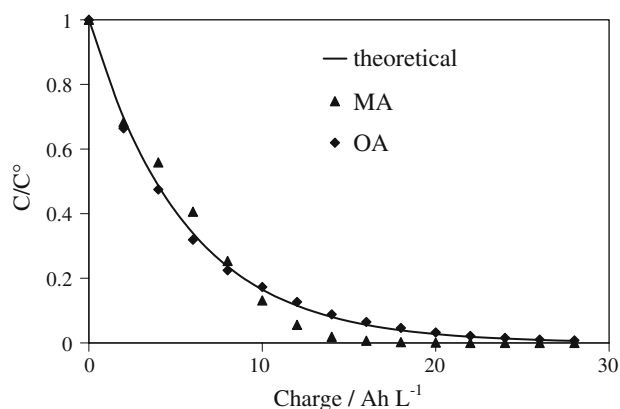
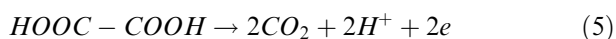

Fig. 9. Variation of the dimensionless concentration of maleic and oxalic acids and theoretical curve during electrolysis of a solution containing maleic acid (0.05 M) and oxalic acid (0.05 M) in 1 M perchloric acid. $I = 2 \text{ A}$ (40 mA cm^{-2} .)

concentrations of both acids decreased at rates of the same order. In Figure 5 it was seen that the amount of OA produced by MA oxidation was small compared with its initial concentration; so it is assumed that the oxidation processes for MA and OA have limiting steps of the same nature.

The rate constant value of the reaction between hydroxyl radicals and OA in aqueous solution is $1.4 \times 10^6 \text{ L mol}^{-1} \text{ s}^{-1}$ [16]; this constant is 4285 times lower than that for MA. If MA and OA oxidation were due only to the action of the hydroxyl radicals, the MA should disappear before the OA. Furthermore, under galvanostatic conditions, MA adsorption on the electrode surface (see section 3.1.1) should not take place because of its rapid reaction with OH^\cdot radicals produced by electrolysis under controlled current. Consequently, unlike potentiostatic conditions, the OA oxidation should not be hindered by MA adsorption. Under galvanostatic conditions, the oxidation of OA by direct transfer of electrons seems to be possible. In the case of a rate limitation by mass transfer, OA concentration should follow an exponential decline: $C = C^0 \exp(-t/\tau)$. The time constant τ is defined by: $\tau = V/(k_d S)$. Considering the values of the volume ($V = 500 \text{ cm}^3$), the area of the anode ($S = 50 \text{ cm}^2$) and the mass-transfer coefficient ($k_d = 0.002 \text{ cm s}^{-1}$), the constant τ is 5000 s. Figure 9 shows the dimensionless concentration of the two acids as function of time, together with the calculated curve. The experimental points for the OA correspond perfectly to the theoretical curve for mass-transfer limitation. The same is not exactly true for MA, and this is in agreement with the assumption of different mechanisms when these two molecules are in competition for oxidation. In summary, under the conditions of this experiment, the oxidation of OA takes place by direct transfer of electrons with the anode:



3.2.4. Maleic, oxalic and formic acids in the same solution

Figure 10 shows the variations in concentration when the three acids are initially present at the same concentration (0.045 M). MA and OA were oxidized at fairly similar rates: this result is similar to that shown in Figure 8. When MA and OA reached 40% of their initial quantity, FA then began to decrease (Figure 10). The concentration of FA increased slightly at the beginning of the electrolysis: this means that its rate of production by oxidation of MA was greater than its rate of consumption by oxidation. It was verified that the OA concentration followed an exponential decline with time in agreement with the result in Figure 9. Under these working conditions, the OA oxidation seems once again to be performed by direct electron exchange at the electrode. It is important to note that the presence of MA is likely to modify the relative rates of oxidation of the different compounds on the BDD electrode. Marselli et al. [2] had, in fact, shown that in the case of the presence of both OA and FA, the latter was oxidized first, with degradation of OA only beginning when almost all the FA had been oxidized. This difference can be explained by the very high reaction rate with the hydroxyl radicals that characterizes the MA oxidation process.

4. Conclusion

This investigation has shown that maleic acid can be mineralized using a BDD anode. The main intermediaries in the electrochemical degradation of MA are oxalic and formic acids. A comparative kinetic study between these acids was performed to understand the role of MA in the oxidation of OA and FA. Under galvanostatic conditions, OA seems to degrade by direct electron transfer while FA oxidizes by reaction with hydroxyl radicals.

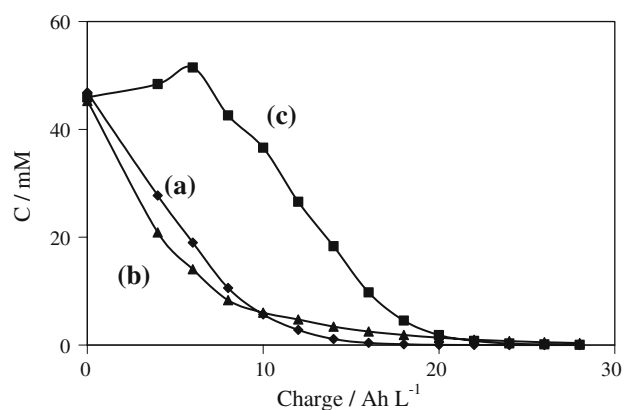

Fig. 10. Concentration variation during electrolysis of 0.5 L solution containing maleic (0.045 M), oxalic (0.045 M) and formic (0.045 M) acids in 1 M perchloric acid. $I = 2 \text{ A}$ (40 mA cm^{-2}). (a) maleic acid; (b) oxalic acid; (c) formic acid.

References

1. M. Pourbaix, Atlas of Electrochemical Equilibria in aqueous Solutions 2nd ed. (Nace International Cebelcor, 1974).
2. B. Marselli, J. Garcia-Gomez, P.A. Michaud, M.A. Rodrigo and Ch. Comninellis, *J. Electrochem. Soc.* **150** (2003) D79.
3. F. Bonfatti, S. Ferro, F. Lavezzo, M. Malacarne, G. Lodi and A. De Battisti, *J. Electrochem. Soc.* **146** (6) (1999) 2175.
4. Ch. Comninellis and C. Pulgarin, *J. Appl. Electrochem.* **23** (1993) 108.
5. N. Belhadj Tahar and A. Savall, *J. Electrochem. Soc.* **145** (1998) 3427.
6. J.J. Carey, C.S. Christ and S.N. Lowery (US Patent 5399247, 1995).
7. G. Gandini, P.A. Michaud, I. Duo, E. Mahé, W. Haenni, A. Perret and Ch. Comninellis, *New Diamond Front. Carbon Technol.* **9** (1999) 303.
8. P. Cañizares, J. García-Gómez, J. Lobato and M.A. Rodrigo, *Ind. Eng. Chem. Res.* **42** (2003) 956.
9. M. Ueda, A. Watanabe, T. Kameyama, Y. Matsumo, M. Sekimoto and T. Shimamune, *J. Appl. Electrochem.* **25** (1995) 817.
10. U. Schumann and P. Gründler, *Wat. Res.* **32**(9) (1998) 2835.
11. W. Haenni, H. Baumann, Ch. Comninellis, D. Gandini, P. Niedermann, A. Perret and N. Skinner, *Diamond Relat. Mater.* **7** (1998) 569.
12. M.J. Chollier, F. Epron, E. Lamy-Pitara and J. Barbier, *Catal. Today* **48** (1999) 291.
13. M. Panizza, P.A. Michaud, G. Cerisola and Ch. Comninellis, *J. Electroanal. Chemistry* **507** (2001) 206.
14. G.V. Buxton, C.L. Greenstock, W.P. Helman and A.B. Ross, *J. Phys. Chem. Ref. Data* **17** (1988) 513.
15. D.E. Cabelli, B.H.J. Bielski and Z. Naturforsch, *B Anorg. Chem. Org. Chem.* **40** (1985) 1731.
16. N. Getoff, F. Schwoerer, V.M. Markovic, K. Sehested and S.O. Nielsen, *J. Phys. Chem.* **77** (1971) 749.